

INSTALLATION & OPERATION INSTRUCTIONS**GENERAL INFORMATION**

1. Clean the lines upstream of valve particles larger than 1/16" diameter (welding slag, pipe scale and other contaminants). Griswold Controls recommends the use of a strainer upstream to prevent damage or blockage.
2. Air should be eliminated from the system so valves remain full of fluid during operation. All PI valves trap air in the regulator section of the valve. If the air is not removed, one of the effects is a valve that may pulsate with a mild or violent shaking force. The normal process of bleeding air from a system will not remove this air because the air is trapped within a chamber. A convenient way to bleed the air is to cycle the valve closed, wait 10-15 seconds, then open it. This exhausts air out of the diaphragm chamber and into the pipe where it can later rise to a high point for extraction. In a building with several valves, it is most convenient to

perform this from a central building automation control. We recommend sequentially closing one valve at a time to minimize the disruption to occupants. If the building is not occupied it is acceptable to cycle all the valves at once as long as there is a method in place to keep the system pressure differential to within the valve differential pressure range. In the event that vibration persists, the MVP products have a pressure response valve (PRV) for additional control over the regulator response time. It's a small needle valve located on the bottom of the valve at the center of a hex nut designed to control the response time of the valve as it corrects for pressure fluctuations. Screw the small needle valve clockwise to close. **DO NOT over tighten as it is a small brass screw and can easily be damaged.** Then open it about a 1/4 turn. This will slow down the response and should further suppress vibration.

3. All styles of Griswold 2-way flow control valves are marked to show the direction of flow. THE FLOW ARROW MUST POINT IN THE DIRECTION OF FLOW FOR PROPER OPERATION.
4. Do not use boiler additives, chemicals which are petroleum based or contain mineral oil, hydrocarbons, azole compounds or ethylene glycol acetate. Compounds which can be used, with minimum 50% water dilution, are diethylene glycol, ethylene glycol, and propylene glycol. If installing these valves in an addition or retrofitting an existing building, do not assume that the fluid in the existing piping meets these criteria.
5. Do not install valves at pump discharge. Minimum of 8 pipe diameters (or 8 feet) is required before the valve.

MECHANICAL INSTALLATION**UNION CONNECTIONS**

1. When soldering union sweat-end ball valves, remove the union nut and slide over the pipe. Then sweat the tailpiece to the pipe. If there are sweat ends on both sides, repeat the same steps for each end. Next, install the valve body assembly between the tailpieces and tighten the union nuts. This will prevent damage to the O-rings.

O-RING REPLACEMENT

1. Assembly must be made with care to protect the O-ring from damage during installation. Some of the most important features to ensure this are:
 - Cleanliness is important for proper seal action and long O-ring life. Foreign particles like dirt, metal chips, etc. in the O-ring groove may cause O-ring leakage and can damage the O-ring thus reducing its life.
 - Using silicon oil or grease lubricant at assembly helps protect the O-ring from damage by abrasion, pinching or cutting. Do not use aerosol products or petroleum-based lubricants. The lubricant should not excessively soften or harden.
 - The O-ring should be placed in the groove.

FLANGE CONNECTIONS

1. O-rings are supplied with the valve and are used to seal the connections. Place the o-ring in the grooves in the inlet and outlet of the valve body.
2. Using silicon oil or grease lubricant at assembly helps protect the O-ring.
3. 2-1/2"-3": 4 holes flanges require (4) 5/8" X 2-3/4" bolts and (2) 5/8" X 12-1/2" studs. Valves are not compatible with slip on flanges.
4. All other sizes: 8 holes flanges require (8) 5/8" X 2-3/4" bolts and (4) 5/8" X 12-1/2" studs. 2-1/2" to 4" valves are compatible with both Class 150 and Class 300 flanges. 5" valve is compatible with Class 150 flanges and/or Class 300, 5" flanges

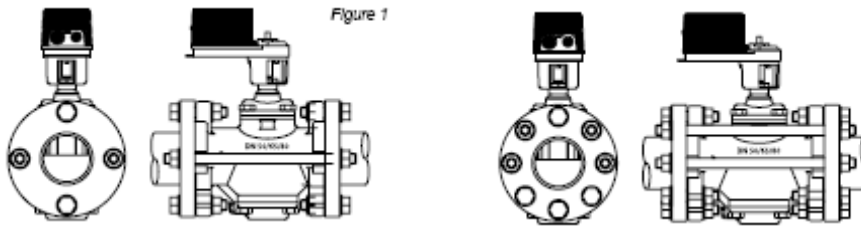
**ELECTRICAL INSTALLATION****FITTING AND ORIENTATION OF THE ACTUATOR**

To fit the actuator on the valve body, please grease the o-ring on the spindle adaptor and place the spindle adaptor on the valve spindle. Place the actuator on the spindle adaptor and place the three actuator "legs" into the three holes in the mounting bracket. Make sure that the snap ring is clicked onto the mounting bracket, so that the snap ring is locked at the top of the mounting bracket, but is able to rotate. Then turn the snap ring counter clockwise (upside view) approximately 1/6 of a turn until its stop points touch the actuator "legs" and the mounting is locked with a (small) click.

To remove the actuator, please reverse the procedure, i.e. turn the snap ring clockwise until the actuator is loosened and lift the actuator up. To ease removal of actuator, make sure that the valve is not fully closed.

Symbols at the bottom side of the actuator also indicate how to lock and unlock the actuator with the snap ring.

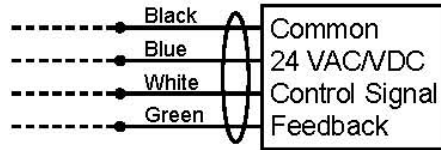
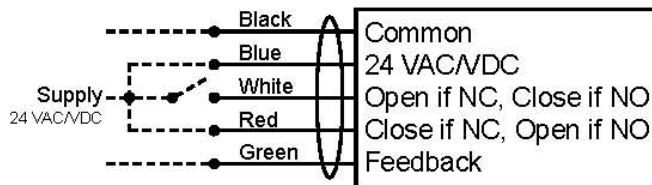
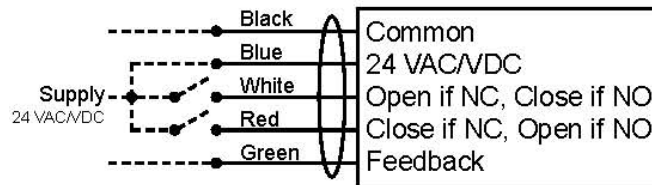
WIRING DIAGRAM**Analog****Digital - 2 position****Digital - 3 point floating**

If feedback signal is not required, leave green wire detached.

FITTING AND ORIENTATION OF THE ACTUATOR

When power to the actuator is turned on, the actuator will automatically calibrate:

- Valve is calibrating to determine closing point. This calibration can take up to 10 minutes depending on the valve's position at start-up. During calibration lower part of display will show "CAL".
- If no control signal is detected, flush is started if enabled in programming menu (enabled by default), opening valve to 5/6 of fully open. Lower part of display will show "FLUSH" until control signal is detected.
- When control signal is present, actuator will adjust to current control signal and proceed with normal operation.

At first start-up please enter programming menu to adjust actuator settings.

ACTUATOR WIRING AND PROGRAMMING





The programming menu is always accessible. To enter the programming menu, please simultaneously press the two arrow buttons (→ and ←) for 6 seconds, until bottom line blinks.

Generally, press → **button** to accept value and go to next step and press ← button to go to previous step. To change the value, pls. press ▲ or ▼ keys, for quick scroll through values hold down the button.

Press and simultaneously for 6 sec. to exit programming menu. Actuator will automatically return to operation mode if no action is detected on arrow keys during 1 minute.

All values selected in the programming menu are stored in non-volatile memory.

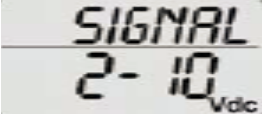
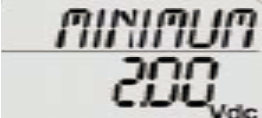
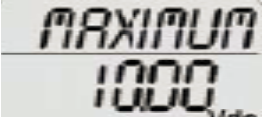
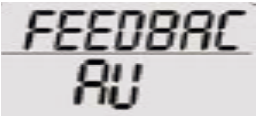
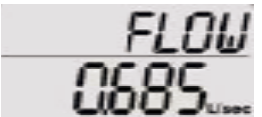
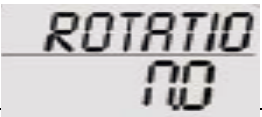
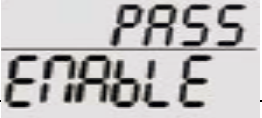
Step	Display	Description	Values
0		Password. <i>*scrolling top:</i> ENTER PASS WORD	Disabled by default Password: 3569266. <i>Only if Enabled (in step 11).</i> Change one digit at a time, press → and ← to move between digits. At last digit, press → to go to next step.
1		Select language. <i>*scrolling top:</i> SELECT LANGUAG	Default: English. Possibility to choose other languages later on (not currently an option).
2		Select valve model onto which the actuator is installed. <i>*scrolling top:</i> SELECT VALVE MODEL	Default: SM.0.0 Select from the available valve models using this cross reference. MVP31_=SM.3.1; MVP32_=SM.3.2; MVP41_=SM.4.1; MVP42_=SM.4.2; MVP51_=SM.5.1; MVP52_=SM.5.2 MVP61_=SM.6.1; MVP62_=SM6.2
3		Choose unit scale for flow rate. <i>*scrolling top:</i> SELECT UNIT SCALE	Default: l/sec. Options: l/sec or l/hr or GPM.
4		Activate Flush mode at start-up. <i>*scrolling top:</i> SELECT FLUSH MODE	Default: Enable. Options: Enable or Disable. When no control signal (analog) is detected at start up, flush mode is started (5/6 of fully opened). It will be dismissed when control signal is detected.

5		<p>Select type of control signal.</p> <p><i>*scrolling top:</i> SELECT CONTROL SIGNAL</p>	<p>Default: 2-10VDC. Options: 2-10VDC or 4-20mA or digital. Choose:</p> <ul style="list-style-type: none"> • 2-10VDC for VDC • 4-20mA for mA • Digital for 2 position or 3 point floating.
6		<p>Select minimum control value.</p> <p><i>*scrolling top:</i> SET MINIMUM LIMIT</p>	<p><u>Volt default: 2.</u> Options: from 0-7. Increment: 0.1. <u>mA default: 4.</u> Options: from 0-14. Increment: 0.2. <i>NA if Digital (in step 5).</i></p>
7		<p>Select maximum control value.</p> <p><i>*scrolling top:</i> SET MAXIMUM LIMIT</p>	<p><u>Volt default: 10.</u> Options: from 3-10 and at least 3 VDC greater than the selected minimum limit. Increment: 0.1. <u>mA default: 20.</u> Options: from 6-20 and at least 6 mA greater than the selected minimum limit. Increment: 0.2. <i>NA if Digital (in step 5).</i></p>
8		<p>Select feedback signal.</p> <p><i>*scrolling top:</i> SELECT FEEDBACK SIGNAL</p>	<p><u>Default: AU; Automatic match of control signal if analog.</u> Options: 0-10 VDC, 2-10 VDC or 4-20 mA or AU. <i>If Digital (in step 5) AU is not an option.</i></p>
9		<p>Set the designed maximum flow. <i>Accuracy: Greatest of either ±5% of designed max. flow or ±2% of max. valve flow.</i></p> <p><i>*scrolling top:</i> SELECT MAXIMUM FLOW</p>	<p>Default: Maximum setting. Values depend on valve model and unit scale chosen in step 2 and 3. Stepping increments as per tech note.</p>
10		<p>Select direction of rotation.</p> <p><i>*scrolling top:</i> SELECT ROTAT DIRECT</p>	<p>Default: Normally Closed (NC). Options: Normally Open (NO) or Normally Closed (NC).</p>
11		<p>Activation of password.</p> <p><i>*scrolling top:</i> ACTIVAT PASS WORD</p>	<p>Default: Disable. Options: Enable or Disable. If Enabled password is required to access alarm and programming menu.</p>
12		<p>Select direction of rotation when Failsafe.</p> <p><i>*scrolling top:</i> SELECT FAIL SAFE DIRECT</p>	<p>Default: Closed. Options: Open or Closed. <i>Only valid for failsafe model. Failsafe direction open means opening to max. flow chosen in step 9.</i></p>



Notes about Failsafe mode

If power supply is out of range or lost, failsafe mode will be activated:

1. Approx. 80 sec. delay.
2. Actuator opens/closes valve (according to failsafe direction chosen in programming menu).
3. Actuator shuts off.

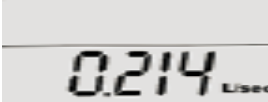

If power supply is restored during action 1. or 2., failsafe mode is deactivated.

IN OPERATION

Display	Description	Values
	Indicates unit scale system.	l/sec or l/min or GPM. mA or VDC.
	Alarm indicator.	Blinking if actuator is still functional (warning). Fully on if actuator is not working (critical).
	Current Flowrate ¹	Indicates current flow rate in l/sec, l/hr or GPM.



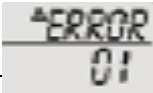





ALARM MENU

To enter the alarm menu, simultaneously press ▲ and ▼ for 6 seconds. You can access the alarm menu only if an alarm is present. Press → to go to the next alarm display, press ← to return to previous step. Press ▲ and ▼ simultaneously for 6 seconds to exit alarm menu. Actuator will automatically return to operation mode if no action is detected on arrow keys during 1 minute.

Display	Description	Values
	Alarm	
	Enter password.	If enabled in programming menu step 11 Disabled by default. Password: 3569266.

Code	Icon	Description	Details
------	------	-------------	---------

¹ Note that the flow rate displayed on the actuator is a calculated value based upon differential pressure being within control range. If display shows “NA” instead of current flow rate, it indicates that the flow rate is below minimum defined flow rate according to tech note, or that valve model has not been chosen in programming menu step 2.

01		Valve/actuator is over torqued.	Operation is stopped. Actuator will retry operation every 4 minutes. If over torque condition disappears, error will convert to error code 02.
	FULL ON		
02		Actuator has reached its torque limit in the past.	Actuator is functioning. To reset the alarm simultaneously press ▲ and ← for 6 seconds
	BLINKING		
03		Critical - over temperature.	Critical: Temperature in actuator is at least 70°C, motor operation is stopped. If temperature is decreasing, operation will resume.
	FULL ON		
04		High temperature.	Actuator is still functioning. Temperature in actuator is at least 50°C/122 °F. If temperature is decreasing, operation will resume.
	BLINKING		
05		No Failsafe: Power supply not in range.	Operation is stopped. Alarm will automatically reset when voltage is back in range.
	FULL ON		
		With Failsafe: Power supply not detected / not in range.	Failsafe is activated. Alarm will automatically reset when voltage is back in range.
	BLINKING		
06		Control signal not detected.	Operation is stopped. Alarm will automatically reset when control signal is back in range.
	FULL ON		
07		Battery error.	Battery is not properly connected. Alarm will reset when battery is properly connected.
	BLINKING		<i>Only valid for failsafe model</i>

In case of ERRORS or ALARM

If actuator is still functioning (error 02, 04, 05 with failsafe and 07 with failsafe) the ALARM icon will flash. Error codes can be found in the alarm menu.

If actuator is not functioning (error 01, 03, 05 without failsafe and 06) the ALARM icon is turned on. The error code will be available in the information in the upper part of the display and the alarm menu.

AUTO STROKE RECALIBRATION

In case the valve does not operate as expected, start the auto-stroke sequence to re-calibrate the closing point of the valve and to make sure that the actuator is able to open the valve fully. Press buttons → and ▲ simultaneously for 6 seconds to start the autostroke.

Auto-stroke sequence. (display shows: "AUTO STROKE CYCLES"):

1. Valve is closed to determine closing point.
2. Valve is opened fully (independent of max. flow chosen).
3. System returns to normal operation.

If actuator is not able to open valve fully, an error will be displayed. An auto-stroke cannot be cancelled.

MANUAL OVERRIDE

Manual override is used to temporarily set the position of the valve regardless of the settings and control signal for the actuator.

1. Turn off power to the actuator.
2. Remove actuator from valve as described.
3. Turn spindle to the relevant position (Clockwise to close valve, counter clockwise to open valve). Be sure not to use more than 10 Nm torque. Please protect actuator from water while not on valve.
4. Re-mount actuator on valve as described.
5. Turn on power to the actuator when normal operation is needed.

OPERATION

1. Ensure that the valve is not in the fully closed position when filling the system with water.
2. Do not exceed maximum pressure differential control range for valve.
3. Install valve indoors. If valve is installed outdoors, water tight protection is required for the actuator.
4. If the valve is to be installed in vertical pipe on a chilled water system, ensure that the covered electronics are upwards above the valve spindle, to prevent condensation from entering the electronics. If necessary use a socket and ratchet to remove the brass nut attaching the mounting bracket to the valve body, re-position the Actuator and replace the brass nut.

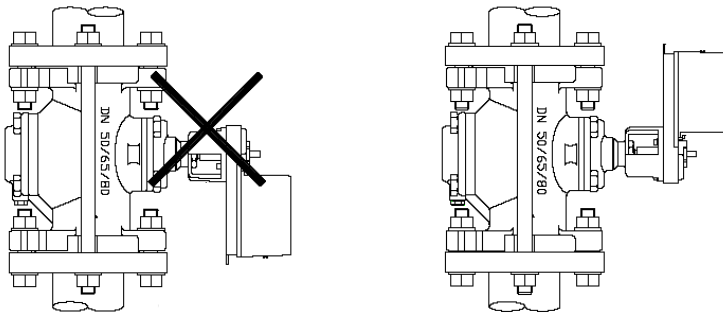

MAINTENANCE

1. If the system experiences large amounts of pipe scale due to poor water conditions, as sometimes found in older or retrofit pipe systems, provisions should be made to keep the system clean. Proper water treatment is also recommended by the use of a Griswold Separator.
2. IF A GRISWOLD SEPARATOR IS NOT USED FOR SYSTEM CLEANING, THE VALVES SHOULD BE CHECKED ANNUALLY.

FLOWRATE VERSUS VALVE POSITION

2-1/2" - 3" 4.5-87psid	2-1/2" - 3" 5.1 - 87psid	3" - 4" 4.5-87psid	3" - 4" 5.1-87psid	3" - 4" 7.3-87psid	5" - 6" 4.5-87psid	5" - 6" 5.1-87psid	8" - 10" 5.1-87psid		Stem Rotations From Closed
GPM	GPM	GPM	GPM	GPM	GPM	GPM	GPM		Rotations
40.7	56.3	55.4	75.0	58.3	103	113	146	911	1.0
44.6	61.0	61.6	83.8	70.0	115	128	154	924	1.1
48.3	65.5	67.5	92.3	81.3	126	142	162	936	1.2
51.9	69.9	73.0	100	92.3	138	157	171	948	1.3
55.2	74.0	78.4	108	103	149	170	182	960	1.4
58.4	78.0	83.4	115	113	160	183	192	972	1.5
61.5	81.7	88.1	122	123	170	196	204	983	1.6
64.3	85.3	92.6	129	133	180	208	216	994	1.7
67.0	88.8	96.9	135	142	190	220	229	1000	1.8
69.6	92.1	101	141	152	199	232	242	1010	1.9
72.0	95.2	105	147	160	208	243	256	1020	2.0
74.2	98.2	108	152	169	217	253	271	1030	2.1
76.4	101	111	157	177	226	264	286	1040	2.2
78.4	104	115	162	185	234	273	301	1050	2.3
80.2	106	117	167	193	242	283	317	1060	2.4
82.0	109	120	171	200	249	292	333	1070	2.5
83.7	111	123	175	207	257	301	349	1080	2.6
85.2	113	125	178	214	264	309	366	1080	2.7
86.6	115	127	182	221	271	317	383	1090	2.8
88.0	117	129	185	227	277	325	400	1100	2.9
89.2	119	131	188	233	284	333	417	1110	3.0
90.4	121	132	191	239	290	340	435	1110	3.1
91.5	123	134	194	245	295	347	452	1120	3.2
92.5	124	135	196	250	301	353	470	1130	3.3
93.5	126	137	198	255	306	360	488	1130	3.4
94.4	127	138	200	260	311	366	506	1140	3.5
95.2	129	139	202	265	316	372	523	1140	3.6
96.0	130	140	204	269	320	377	541	1150	3.7
96.8	131	140	205	274	325	383	559	1150	3.8
97.5	133	141	207	278	329	388	577	1160	3.9
98.2	134	142	208	281	333	393	595	1170	4.0
98.8	135	142	209	285	336	398	613	1170	4.1
99.4	136	143	210	288	340	402	630	1180	4.2
101	137	143	212	292	343	407	648	1180	4.3
101	138	143	213	295	346	411	665	1190	4.4
101	139	144	214	297	349	415	682	1190	4.5
102	140	144	214	300	351	419	699	1200	4.6
102	141	144	215	303	354	423	716	1200	4.7
103	142	145	216	305	356	427	732	1210	4.8
104	143	145	217	307	358	431	749	1210	4.9
104	144	145	217	309	360	434	765	1220	5.0
105	145	145	218	311	361	438	781		5.1
106	147	145	218	312	363	441	796		5.2
106	148	146	219	314	364	445	812		5.3
107	149	146	220	315	365	448	827		5.4
108	150	146	220	316	366	451	842		5.5
109	151	147	221	317	367	455	856		5.6
110	153	147	222	318	368	458	870		5.7
111	154	148	223	319	368	461	884		5.8
112	155	148	224	320	369	464	898		5.9
113	157	149	225	320	369	468	911		6.0